



POWERWARE® 5125

Extended Battery Module

User's Guide

For use with Two-in-One, 1000–1500 VA Models

www.powerware.com

Powerware is a registered trademark of Powerware Corporation.

© Copyright 2003 Powerware Corporation, Raleigh, NC, USA. All rights reserved. No part of this document may be reproduced in any way without the express written approval of Powerware Corporation.



TABLE OF CONTENTS

1 Introduction	1
Safety Warnings	2
Sikkerhedsanvisninger	2
Belangrijke Veiligheidsinstructies	3
Tarkeita Turvaohjeita	3
Consignes de sécurité	4
Sicherheitswarnungen	4
Avvisi di sicurezza	5
Viktig Sikkerhetsinformasjon	6
Regulamentos de Segurança	6
Advertencias de Seguridad	7
Säkerhetsföreskrifter	8
2 Installation	9
Inspecting the Equipment	9
EBM Installation	9
Rack-Mount Installation	10
Tower Installation	12
3 Maintenance	15
UPS and Battery Care	15
Storing the UPS and Batteries	15
When to Replace Batteries	15
How to Replace Extended Battery Modules	16
Testing New Batteries	17
Recycling the Used Battery	18



CHAPTER 1

INTRODUCTION

The Extended Battery Module (EBM) can be added to the Powerware® 5125 to extend the available UPS battery time (see Table 1). Up to four EBMs can be installed with the Powerware 5125.

Table 1. Battery Run Times (in Minutes at Full/Half Load)

Model	Internal UPS Batteries	1 EBM	2 EBMs	3 EBMs	4 EBMs
1000 VA	7/19	33/68	58/120	82/166	105/214
1500 VA	5/13	23/57	49/161	73/177	96/205

NOTE Battery times are approximate and vary depending on the load configuration and battery charge.

With the hot-swappable battery feature, UPS batteries can be added or replaced easily without turning the UPS off or disconnecting the load.

If you prefer to remove input power to change the battery: 1) Press and hold the Off  button until the long beep ceases (approximately five seconds), then unplug the UPS; 2) Wait 60 seconds while the internal processor shuts down before you disconnect the battery.

Safety Warnings

Read the following precautions before you install the EBM.

IMPORTANT SAFETY INSTRUCTIONS SAVE THESE INSTRUCTIONS

This manual contains important instructions that you should follow during installation and maintenance of the EBM. Please read all instructions before operating the equipment and save this manual for future reference.



CAUTION

- Batteries can present a risk of electrical shock or burn from high short circuit current. Observe proper precautions. Servicing should be performed by qualified service personnel knowledgeable of batteries and required precautions. Keep unauthorized personnel away from batteries.
- Proper disposal of batteries is required. Refer to your local codes for disposal requirements.
- This UPS contains its own energy source (batteries). The UPS output receptacles may carry live voltage even when the UPS is not connected to an AC supply.
- Never dispose of batteries in a fire. Batteries may explode when exposed to flame.

Sikkerhedsanvisninger



ADVARSEL

- Batterier kan udgøre en fare for elektrisk stød eller forbrændinger forårsaget af høj kortslutningsspænding. De korrekte forholdsregler bør overholdes.
- Korrekt bortskaffelse af batterier er påkrævet. Overhold gældende lokale regler for bortskaffelsesprocedurer.
- Denne UPS indeholder egen energiforsyning (batterier). Udgangsstikkene kan lede strøm, selv når UPS'en ikke er tilsat en AC-energikilde.
- Skaf dig aldrig af med batterierne ved at brænde dem. Batterierne kan eksplodere ved åben ild.

Belangrijke Veiligheidsinstructies



OPGELET

- Batterijen kunnen gevaar voor elektrische schok of brandwonden veroorzaken als gevolg van een hoge kortsluitstroom. Volg de desbetreffende aanwijzingen op.
 - De batterijen moeten op de juiste wijze worden opgeruimd. Raadpleeg hiervoor uw plaatselijke voorschriften.
 - Deze UPS bevat zijn eigen energiebron (batterijen). De uitgangsaansluitingen kunnen onder spanning staan wanneer de UPS niet op een wisselstroom voeding is aangesloten.
 - Nooit batterijen in het vuur gooien. De batterijen kunnen ontploffen.
-

Tarkeita Turvaohjeita



VARO

- Akusto saattaa aiheuttaa sähköiskun tai syttyä tuleen, jos akusto kytketään oikosulkuun. Noudata asianmukaisia ohjeita.
 - Akusto täytyy hävittää säädösten mukaisella tavalla. Noudata paikallisia määräyksiä.
 - Tämä UPS sisältää oman energialähteen (akuston). Ulostuloliittimissä voi olla jännite, kun UPS ei ole liitettyä verkkojännitteeseen.
 - Älä koskaan heitä akkuja tuleen. Ne voivat räjähtää.
-

Consignes de sécurité



ATTENTION!

- Les batteries peuvent présenter un risque de décharge électrique ou de brûlure par des courts-circuits de haute intensité. Prendre les précautions nécessaires.
 - Une mise au rebut réglementaire des batteries est obligatoire. Consulter les règlements en vigueur dans votre localité.
 - Cet onduleur renferme sa propre source d'énergie (batteries). Les prises de sortie peuvent être sous tension même lorsque l'onduleur n'est pas branché sur le secteur.
 - Ne jamais jeter les batteries au feu. L'exposition aux flammes risque de les faire exploser.
-

Sicherheitswarnungen



VORSICHT!

- Batterien können aufgrund des hohen Kurzschlußstroms Elektroschocks oder Verbrennungen verursachen. Die entsprechenden Vorsichtsmaßnahmen sind unbedingt zu beachten.
 - Die Batterien müssen ordnungsgemäß entsorgt werden. Hierbei sind die örtlichen Bestimmungen zu beachten.
 - Diese USV ist mit einer eigenen Energiequelle (Batterie) ausgestattet. An den Ausgangssteckdosen kann auch dann Spannung anliegen, wenn die USV nicht an einer Wechselspannungsquelle angeschlossen ist.
 - Batterien niemals verbrennen, da sie explodieren können.
-

Προειδοποιήσεις Ασφάλειας



ΠΡΟΣΟΧΗ

- Οι συσσωρευτές μπορεί να προκαλέσουν ηλεκτροπληξία ή έγκαυμα από υψηλό ρεύμα βραχυκυκλώματος. Λαμβάνετε τις κατάλληλες προφυλάξεις.
 - Απαιτείται σωστή διάθεση των συσσωρευτών. Δείτε τους τοπικούς κανονισμούς που αφορούν τις απαιτήσεις διάθεσής τους.
 - Το συγκεκριμένο UPS περιέχει τη δική του πηγή ενέργειας (συσσωρευτές). Οι ρευματοδότες εξόδου μπορεί να έχουν ενεργό τάση ακόμη και όταν το UPS δεν είναι συνδεδεμένο σε πηγή εναλλασσόμενου ρεύματος (AC).
 - Ποτέ μην πετάτε τους συσσωρευτές στη φωτιά, γιατί μπορεί να εκραγούν.
-

Avvisi di sicurezza



ATTENZIONE

- le batterie possono presentare rischio di scossa elettrica o di ustioni provocate da alta corrente dovuta a corto circuito. Osservare le apposite istruzioni.
 - le batterie devono essere smaltite in modo corretto. Per i requisiti di smaltimento fare riferimento alle disposizioni locali.
 - questo gruppo statico di continuità contiene una fonte di energia autonoma (le batterie). Le prese di uscita possono condurre tensione energizzata quando il gruppo statico di continuità non è collegato con una fonte di alimentazione a corrente alternata.
 - non gettare mai le batterie nel fuoco poichè potrebbero esplodere se esposte alle fiamme.
-

Viktig Sikkerhetsinformasjon



FORSIKTIG

- Batterier kan forårsake elektriske støt eller forbrenning på grunn av høy kortslutningsstrøm. Følg instruksene.
 - Batterier må fjernes på korrekt måte. Se lokale forskrifter vedrørende krav om fjerning av batterier.
 - Denne UPS'en har en egen energikilde (batterier). Stikkontaktene kan være strømførende selv om UPS'en ikke er tilsluttet en vekselstrømforsyning.
 - Kast aldri batterier i flammer, da de kan eksplodere, hvis de utsettes for åpen ild.
-

Regulamentos de Segurança



PERIGO

- As baterias podem apresentar o risco de choque elétrico, ou queimaduras provenientes de alta corrente de curto-circuito. Observe as instruções adequadas.
 - Siga as instruções apropriadas ao desfazer-se das baterias. Consulte os códigos do local para maiores informações sobre os regulamentos de descarte de produtos.
 - Esta UPS contém sua própria fonte de energia (baterias). Os receptáculos de saída podem conter voltagem ativa quando a UPS não se encontra conectada a uma fonte de alimentação de corrente alternada.
 - Nunca jogue as baterias no fogo, porque há risco de explosão.
-

Предупреждения по мерам безопасности



ОСТОРОЖНО

- Аккумуляторы могут вызвать опасность поражения электрическим током или ожога от тока короткого замыкания. Соблюдайте соответствующие меры предосторожности.
 - Необходимо соблюдать правила утилизации аккумуляторов. Обратитесь к местным нормативным актам за информацией о требованиях к утилизации.
 - Данный ИБП содержит собственные источники энергии (аккумуляторы). На выходных розетках может иметься напряжение, даже когда ИБП не подключен к сети переменного тока.
 - Никогда не бросайте аккумуляторы в огонь. Аккумуляторы могут взорваться под воздействием огня.
-

Advertencias de Seguridad



PRECAUCIÓN

- Las baterías pueden presentar un riesgo de descargas eléctricas o de quemaduras debido a la alta corriente de cortocircuito. Preste atención a las instrucciones correspondientes.
 - Es necesario desechar las baterías de un modo adecuado. Consulte las normas locales para conocer los requisitos pertinentes.
 - Este SIE contiene su propia fuente de energía (las baterías). Los receptáculos de salida pueden transmitir corriente eléctrica aun cuando el SIE no esté conectado a un suministro de corriente alterna (c.a.).
 - Nunca deseche las baterías en el fuego. Las baterías pueden explotar si se las expone a la llama.
-

Säkerhetsföreskrifter



VIKTIGT

- Batterierna kan ge elektriska stötar eller brännskador från hög kortslutningsström. Följ tillämpliga anvisningar.
 - Batterierna måste avyttras enligt anvisningarna i lokal lagstiftning.
 - Denna UPS-enhet har en egen energikälla (batterier). De utgående kontakterna kan vara strömförande när UPS-enheten inte är ansluten till en växelströmkälla.
 - Använda batterier får aldrig brännas upp. De kan explodera.
-



CHAPTER 2

INSTALLATION



NOTE If you are installing the UPS and the Extended Battery Module for the first time, follow the installation instructions in the UPS user's guide.

Inspecting the Equipment

If any equipment has been damaged during shipment, keep the shipping cartons and packing materials for the carrier or place of purchase and file a claim for shipping damage. If you discover damage after acceptance, file a claim for concealed damage.

To file a claim for shipping damage or concealed damage: 1) File with the carrier within 15 days of receipt of the equipment; 2) Send a copy of the damage claim within 15 days to your service representative.



NOTE Check the battery recharge date on the shipping carton label. If the date has expired and the batteries were never recharged, do not use or connect the EBM to the UPS. Contact your service representative.

EBM Installation

The Powerware 5125 UPS is designed for flexible configurations and can be installed in a rack or as a standalone cabinet.

If you are installing the EBM in a rack, continue to the following section, "Rack-Mount Installation;" otherwise, continue to "Tower Installation" on page 12.

Rack-Mount Installation

The EBM can be installed in 19-inch racks and needs only 2U of valuable rack space.



CAUTION

The EBM is heavy (65 lb; 29.5 kg). A minimum of two people are required to lift the EBM into the rack.



NOTE Fixed mounting rails are required for each UPS and EBM cabinet. If fixed rails are not already installed in your rack, contact your local distributor to order rail kit(s).

NOTE If you are installing the UPS and the EBM for the first time, follow the installation instructions in the UPS user's guide.

Use the following procedure to install the EBM in a rack:

1. Place the EBM on a flat, stable surface with the front of the EBM facing toward you.
2. Attach the mounting handles to the bracket with the screws provided in the accessory kit (see Figure 1).
3. Align the mounting brackets with the screw holes on the side of the UPS and secure with the supplied screws (see Figure 1).
4. If installing additional EBMs, repeat Steps 1 through 3 for each cabinet.

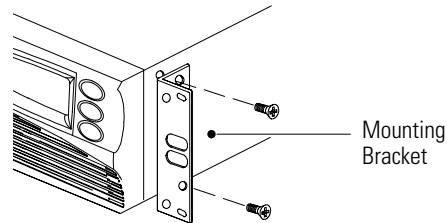

Figure 1. Installing the Mounting Brackets



NOTE The UPS and EBM(s) MUST be installed at the bottom of the rack. If placed in a rack with existing equipment, the rack must be reconfigured to allow the UPS installation at the bottom of the rack.

NOTE The EBM(s) must be installed below the UPS as shown in Figure 2.

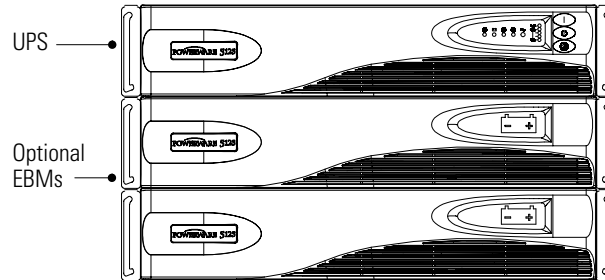

Figure 2. Rack-Mount UPS with EBMs

5. Slide the EBM(s) into the rack.
6. Plug the EBM cable(s) into the battery connectors (see Figure 3). Up to four EBMs may be connected to the UPS.

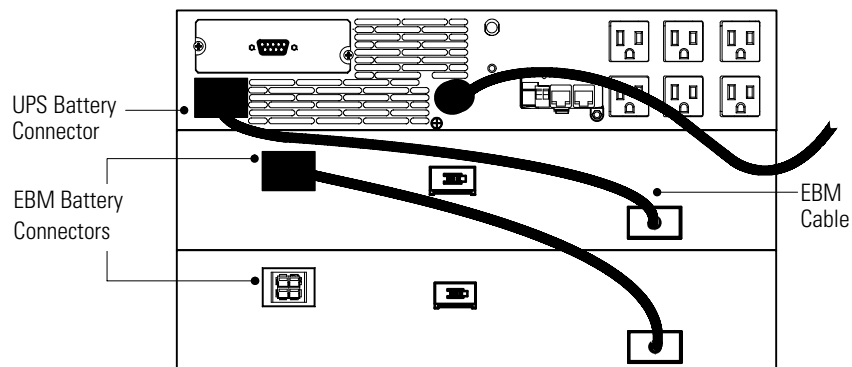

Figure 3. EBM Connections

Tower Installation



NOTE If you are installing the UPS and the EBM for the first time, follow the installation instructions in the UPS user's guide.

NOTE The air vents should be at the top of the unit when positioned vertically.

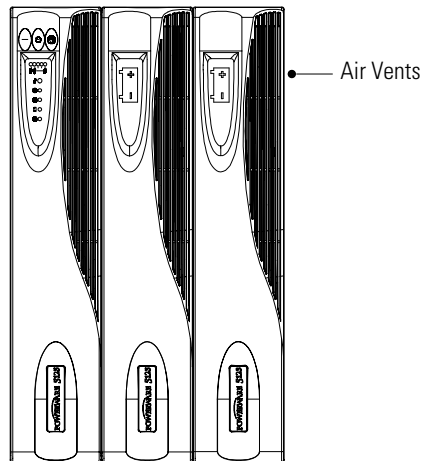

Figure 4. Tower UPS with EBMs

1. Remove the adjacent corner screws from the rear panels as shown in Figure 5 to install the EBM brackets. Discard the screws.
2. Align each EBM bracket with the screw holes and secure with the screws provided in the accessory kit.
3. If installing additional EBMs, repeat Steps 1 and 2 for each cabinet.

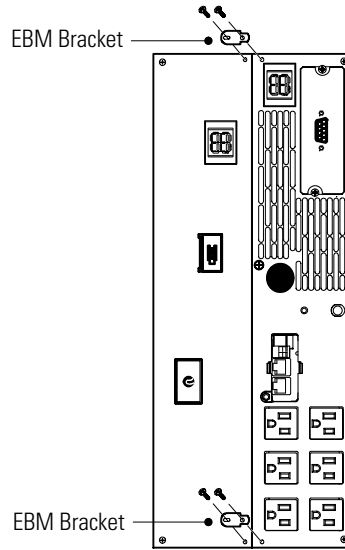

Figure 5. Installing the EBM Brackets

4. Plug the EBM cable(s) into the battery connectors (see Figure 6). Up to four EBMs may be connected to the UPS.

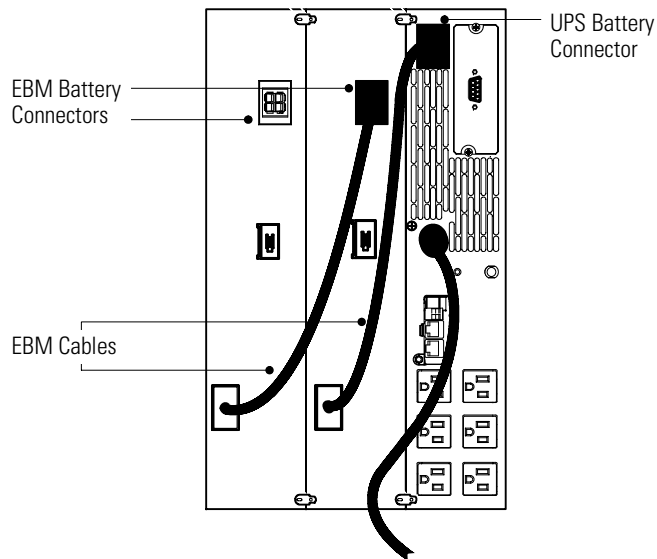

Figure 6. EBM Connections



CHAPTER 3

MAINTENANCE

This section explains how to:

- Care for the UPS and batteries
- Replace the batteries
- Test new batteries
- Recycle used batteries

UPS and Battery Care

For the best preventive maintenance, keep the area around the UPS clean and dust-free. If the atmosphere is very dusty, clean the outside of the system with a vacuum cleaner.



For full battery life, keep the UPS at an ambient temperature of 25°C (77°F).

Storing the UPS and Batteries

If you store the UPS for a long period, recharge the battery every 6 months by plugging the UPS into a power outlet. The batteries charge to 90% capacity in approximately 3 hours. However, it is recommended that the batteries charge for 24 hours after long-term storage.

Check the battery recharge date on the shipping carton label. If the date has expired and the batteries were never recharged, do not use the UPS. Contact your service representative.

When to Replace Batteries

When the  indicator flashes and there is a continuous audible alarm, the batteries may need replacing. Conduct a self-test by pressing and holding the  button for three seconds. If the  indicator stays on, contact your service representative to order new batteries.

How to Replace Extended Battery Modules



NOTE DO NOT DISCONNECT the batteries while the UPS is in Battery mode.

Consider all warnings, cautions, and notes before replacing batteries.



WARNING

- Batteries can present a risk of electrical shock or burn from high short-circuit current. The following precautions should be observed: 1) Remove watches, rings, or other metal objects; 2) Use tools with insulated handles; 3) Do not lay tools or metal parts on top of batteries.
 - ELECTRIC ENERGY HAZARD. Do not attempt to alter any battery wiring or connectors. Attempting to alter wiring can cause injury.
-



NOTE An EBM charges to 90% capacity in approximately 3 hours. However, it is recommended that the batteries charge for 24 hours after installation or long-term storage.

NOTE If more than two EBMs are installed, an external battery charger is recommended for faster recharge times.

Use the following procedure to replace EBMs:

1. Unplug the EBM cable from the UPS.
If additional EBMs are installed, unplug the EBM cable from the battery connector on each EBM.
2. If the UPS is in a tower configuration, remove the EBM brackets.
3. If the UPS is in a rack, install the mounting handles and brackets on the new EBM.
4. Replace the EBM. See “Recycling the Used Battery” on page 18 for proper disposal.
5. Reinstall the EBM brackets if removed in Step 2.
6. Plug the new EBM into the UPS as shown in Figure 7.
For additional EBMs, plug the EBM cable into the battery connector on the adjacent EBM.

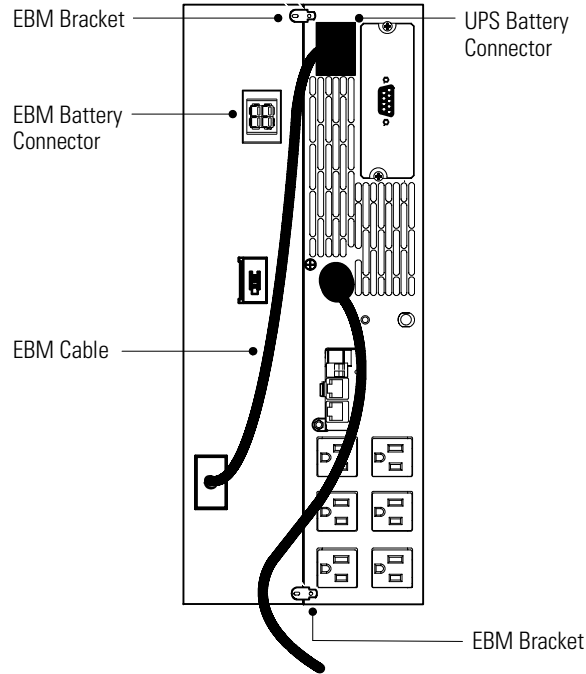





Figure 7. EBM Connections

Testing New Batteries

Press and hold the  button for three seconds to initiate a self-test. After the test is finished, the  indicator should turn off. If the  indicator stays on, check the battery connections. Call your service representative if the problem persists.

Recycling the Used Battery

Contact your local recycling or hazardous waste center for information on proper disposal of the used battery.



WARNING

- Do not dispose of the battery or batteries in a fire. Batteries may explode. Proper disposal of batteries is required. Refer to your local codes for disposal requirements.
- Do not open or mutilate the battery or batteries. Released electrolyte is harmful to the skin and eyes. It may be toxic.



CAUTION

Do not discard the UPS or the UPS batteries in the trash. This product contains sealed, lead-acid batteries and must be disposed of properly. For more information, contact your local recycling or hazardous waste center.